

SUBMITTAL: HUBLESS CAST IRON SOIL PIPE & FITTINGS

UPDATED: MARCH 12, 2021



SUBMITTAL: HUBLESS CAST IRON SOIL PIPE & FITTINGS

Welcome to the NewAge

12630 West Airport Blvd., Suite 100 • Sugar Land, Texas 77478 • Phone: 281.565.0928 • Fax: 281.565.0929 • Toll Free: 1-866.791.7055 • E-Mail: info@newagecasting.com

TABLE OF CONTENTS

Description	Page
Hubless Pipe & Fittings Standards & Certifications.....	3
Standards Certification.....	4
Reference Standards.....	5
UL Certifications.....	6
UPC A 888 Certification.....	7
UPC CISPI 301 Certification.....	8
ICC Certification.....	9
Dimensional Details.....	10 - 18
General Terms and Conditions.....	19



SUBMITTAL: HUBLESS CAST IRON SOIL PIPE & FITTINGS

Welcome to the NewAge

12630 West Airport Blvd., Suite 100 • Sugar Land, Texas 77478 • Phone: 281.565.0928 • Fax: 281.565.0929 • Toll Free: 1-866.791.7055 • E-Mail: info@newagecasting.com

Date: _____ Engineer: _____ Job Name: _____

Contractor: _____ Location: _____

HUBLESS PIPE & FITTINGS STANDARDS & CERTIFICATIONS

Hubless cast iron soil pipe and fittings utilized in drain, waste and vent [DWV] and sewer and storm drainage lines. This system is intended to be used in non-pressurized, gravity-based applications.

All hubless cast iron soil pipe and fittings shall be third party accredited and certified to comply with standard of the most recent version of ASTM A 888 and CISPI 301 including Annex A1. All pipe and fittings shall bare the marking requirements of ASTM A 888 and CISPI 301.

		LISTED AND CERTIFIED BY:		
STANDARDS	ASTM A888	✓	✓	✓
	CISPI 301	✓	✓	✓

Product installation shall conform to the standard industry practices, and all applicable plumbing, fire and building code requirements. Following installation, it is recommended that the system be hydrostatically tested to ten feet of head or 4.3 PSI.

HUBLESS PIPE 10 FOOT LAYING LENGTH				
NOMINAL SIZE	B INSIDE DIAMETER	J OUTSIDE DIAMETER	T	
			NOM.	MIN.
1-1/2	1.50 ± 0.09	1.90 ± 0.06	0.16	0.13
2	1.96 ± 0.09	2.35 ± 0.09	0.16	0.13
3	2.96 ± 0.09	3.35 ± 0.09	0.16	0.13
4	3.94 ± 0.09	4.38 ± 0.09	0.19	0.15
5	4.94 ± 0.09	5.30 ± .09 - .05	0.19	0.15
6	5.94 ± 0.09	6.30 ± .09 - .05	0.19	0.15
8	7.94 ± 0.13	8.38 ± .09 - .05	0.23	0.17
10	10.00 ± 0.13	10.56 ± 0.09	0.28	0.22
12	11.94 ± 0.13	12.50 ± 0.13	0.28	0.22
15	15.11 ± 0.13	15.83 ± 0.13	0.36	0.30

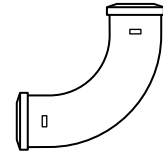

Quarter Bend

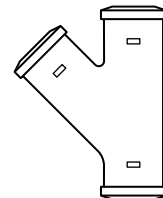

Wye

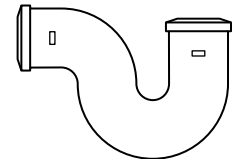

P-Trap

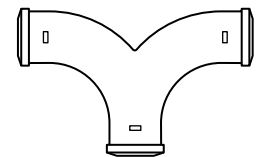

Double Quarter Bend

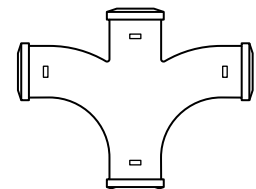

San Cross

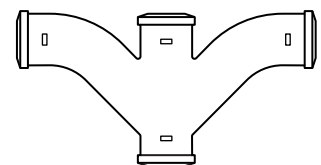

Double Combination Wye

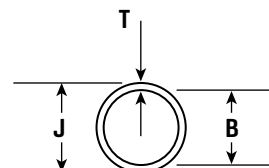
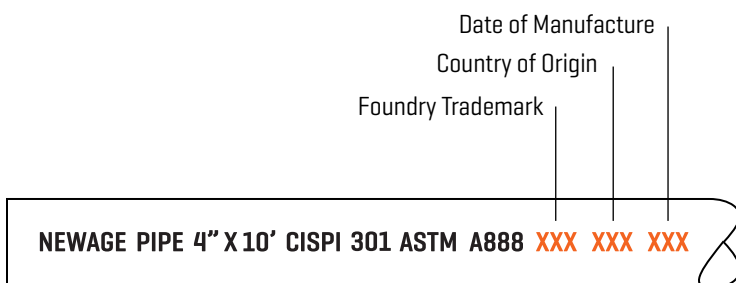



STANDARDS CERTIFICATION

January 29, 2021

This is to certify that all Cast Iron Pipe, Fittings and Couplings sold by New Age Casting Company, meets, or exceeds all applicable standards listed below including the Annex A I:

NO-HUB PIPE AND FITTINGS

All cast iron pipe and fittings are available in traditional bituminous asphalt and our premium New Age Epoxy Coating for corrosion resistance.

ASTM A888
CISPI 301

- Listed by UPC
- Listed by ICC
- Listed by UL

SERVICE HUB AND SPIGOT PIPE AND FITTINGS

All cast iron pipe and fittings are available in traditional bituminous asphalt and our premium New Age Epoxy Coating for corrosion resistance.

ASTM A 74

- Listed by UPC
- Listed by ICC

NO-HUB STANDARD COUPLINGS

CISPI 310
ASTM C 1277

- Listed by UPC

NO-HUB J-IEA VY DUTY (HDC) COUPLINGS

ASTM C 1540

- Listed by UPC

NO-HUB EXTRA HEAVY DUTY (XI-ID) COUPLINGS

ASTM C 1540

- Listed by UPC

SERVICE WEIGHT GASKETS

ASTM C 564
ASTM C 1563

- Listed by UPC

If there are any questions concerning this information or if copies of the certification documentation are needed, please contact your New Age Casting representative or your New Age Casting regional manager.

Sincerely,

Terry Muldowney
Technical Manager
NewAge Casting Company

1/29/2021

Notary Public

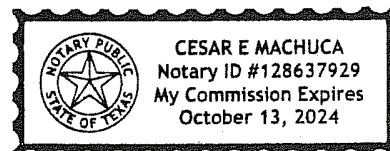



REFERENCE STANDARDS

American Society for Testing and Materials

ASTM	Description
A 74	Standard Specification for Cast Iron Soil Pipe and Fittings
SCOPE:	This specification covers cast iron soil pipe and for use in gravity flow plumbing, drain, waste and vent sanitary, and storm water applications. This pipe and fittings are not intended for pressure applications as the selection of the proper size for sanitary drain, waste, vent, and storm drain systems allows free air space for gravity drainage.
A 888	Standard Specification for No Hub Cast Iron Soil Pipe and Fittings for Sanitary and Storm Drain, Waste, and Vent Piping Applications
SCOPE:	This specification covers no hub cast iron soil pipe and fittings for use in gravity flow applications. This pipe and fittings are intended for non-pressure applications, as the selection of the proper size for sanitary drain, waste, vent, and storm drain systems allows free air space for gravity drainage.
C 564	Standard Specification for Rubber Gaskets for Cast Iron Soil Pipe and Fittings
SCOPE:	This specification covers preformed rubber gaskets used to seal joints in cast iron soil pipe and fittings.
C 1277	Standard Specification for Shielded Couplings Joining No Hub Cast Iron Soil Pipe and Fittings
SCOPE:	It is the purpose of this specification to furnish information as to the characteristics of a sleeve type couplings when applied to cast iron soil pipe and fittings.
C 1540	Standard Specification for Heavy Duty Shielded Couplings Joining No Hub Cast Iron Soil Pipe and Fittings
SCOPE:	This specification covers the evaluating of the performance of heavy duty shielded couplings to join no hub cast iron soil pipe and fittings.

Cast Iron Soil Pipe Institute

CISPI	Description
301	STANDARD SPECIFICATION FOR NO HUB CAST IRON SOIL PIPE AND FITTINGS FOR SANITARY AND STORM DRAIN, WASTE, AND VENT PIPING APPLICATIONS
SCOPE:	Identical to the ASTM A 888
310	SPECIFICATION FOR COUPLING FOR USE IN CONNECTION WITH NO HUB CAST IRON SOIL PIPE AND FITTINGS FOR SANITARY AND STORM DRAIN, WASTE, AND VENT PIPING APPLICATIONS.
Scope:	Identical to the ASTM C 1277

UL CERTIFICATION

CERTIFICATE OF COMPLIANCE

Certificate Number 20180502-MH62513
Report Reference MH62513-20171207
Issue Date 2018-May-02

Issued to: NewAge Casting, LP
12630 West Airport Blvd
Suite 100
Sugar Land TX 77478

This is to certify that representative samples of SOIL PIPE AND FITTINGS, CAST-IRON
See Addendum Page

Have been investigated by UL in accordance with the Standard(s) indicated on this Certificate.

Standard(s) for Safety: ASTM A888, Standard Specification for Hubless Cast Iron Soil Pipe and Fittings for Sanitary and Storm Drain, Waste, and Vent Piping Applications, including Annex A1
CISPI 301, Standard Specification for Hubless Cast Iron Soil Pipe and Fittings for Sanitary and Storm Drain, Waste, and Vent Piping Applications, including Annex A1

Additional Information: See the UL Online Certifications Directory at www.ul.com/database for additional information

Only those products bearing the UL Certification Mark should be considered as being covered by UL's Certification and Follow-Up Service.

Look for the UL Certification Mark on the product.



Bruce Mahrenholz, Director North American Certification Program
UL LLC

Any information and documentation involving UL Mark services are provided on behalf of UL LLC (UL) or any authorized licensee of UL. For questions, please contact a local UL Customer Service Representative at <http://ul.com/aboutul/locations/>



UPC A 888 CERTIFICATION

IAPMO RESEARCH AND TESTING, INC.

5001 E. Philadelphia Street, Ontario, CA 91761-2816 • (909) 472-4100 • Fax (909) 472-4244 • www.iapmort.org



IAPMO R&T Product Listing



This IAPMO R&T Listing is current as of 11/25/2019

Product: Cast Iron Soil Pipe and Fittings (Hubless) File No. 4818

Issued To: NEW AGE CASTING COMPANY
12630 WEST AIRPORT BOULEVARD
SUITE 100
SUGAR LAND, TX 77478

Identification: Each length of pipe and each fitting shall be plainly marked with the country of origin, the manufacturer's name or the manufacturer's registered trademark by which the manufacturer can be readily identified after installation and any appropriate collective mark (optional). The marking shall be adequate identification of the manufacturer of the pipe and fittings if it readily identifies the manufacturer to the end user of the product. Markings shall be cast on fittings. Pipe markings: The pipe shall be marked continuously on the barrel with a minimum of 0.75 inch (19mm) lettering starting within 3 inches of each end of the pipe. Each pipe shall be marked with the date of manufacture. The marking shall be stenciled on the pipe or otherwise applied so as to be clear and legible. Fitting markings: The marking shall be cast with raised letters that are not to be located within the "W" dimension. Cast markings shall be raised from the wall of the fitting unless otherwise noted. Listed products shall bear the UPC® certification mark.

Characteristics: Installed fittings and pipe must be IAPMO R&T listed and installed in accordance with the requirements of the latest edition of the Uniform Plumbing Code

Products listed on this certificate have been tested by an IAPMO R&T recognized laboratory. This recognition has been granted based upon the laboratory's compliance to the applicable requirements of ISO/IEC 17025.

Products are in compliance with the following code(s):

Uniform Plumbing Code (UPC®)
International Plumbing Code (IPC®)

Products are in compliance with the following standard(s):

ASTM A888-2018a (excluding Annex A1)

MODELS:

NO-HUB CAST IRON PIPE:

Model No.	Size
156	1-1/2"
158	2"
160	3"
162	4"
164	5"
168	6"
170	8"
171	10"
172	12"
173	15"



SUBMITTAL: HUBLESS CAST IRON SOIL PIPE & FITTINGS

Welcome to the NewAge

12630 West Airport Blvd., Suite 100 • Sugar Land, Texas 77478 • Phone: 281.565.0928 • Fax: 281.565.0929 • Toll Free: 1-866.791.7055 • E-Mail: info@newagecasting.com

UPC CISPI 301 CERTIFICATION

IAPMO RESEARCH AND TESTING, INC.

5001 E. Philadelphia Street, Ontario, CA 91761-2816 • (909) 472-4100 • Fax (909) 472-4244 • www.iapmort.org



IAPMO R&T Product Listing



This IAPMO R&T Listing is current as of 5/1/2019

Product: Cast Iron Soil Pipe and Fittings (Hubless) File No. 7767

Issued To: NEW AGE CASTING COMPANY
12630 WEST AIRPORT BOULEVARD
SUITE 100
SUGAR LAND, TX 77478

Identification: Each length of pipe and each fitting shall be plainly marked with the country of origin, the manufacturer's name or the manufacturer's registered trademark by which the manufacturer can be readily identified after installation and any appropriate collective mark (optional). The marking shall be adequate identification of the manufacturer of the pipe and fittings of it readily identifies the manufacturer to the end user of the product. Markings shall be cast on fittings.

Characteristics: Hubless cast iron soil pipe and fittings for sanitary and storm drain, waste and vent piping application. To be used in gravity flow, non-pressure application. To be installed in accordance with the requirements of the latest edition of the Uniform Plumbing Code.

Products listed on this certificate have been tested by an IAPMO R&T recognized laboratory. This recognition has been granted based upon the laboratory's compliance to the applicable requirements of ISO/IEC 17025.

Products are in compliance with the following code(s):

- Uniform Plumbing Code (UPC®)
- International Plumbing Code (IPC®)

Products are in compliance with the following standard(s):

- CISPI 301-2017 (excluding Annex A1)

MODELS:

NO-HUB CAST IRON PIPE:

Model No.	Size
156	1-1/2"
158	2"
160	3"
162	4"
164	5"
168	6"
170	8"
171	10"
172	12"
173	15"

NO-HUB FITTINGS:

Short Sweep (MS) Long Sweep

ICC CERTIFICATION



ICC-ES PMG Product Certificate

PMG-1220



Effective Date: November 2019

This listing is subject to re-examination in one year.

www.icc-es-pmg.org | (800) 423-6587 | (562) 699-0543 A Subsidiary of the International Code Council®

CSI: DIVISION: 22 00 00 – PLUMBING
 Section: 22 13 16 – Sanitary Waste and Vent Piping
 Section: 22 14 13 – Facility Storm Drainage Piping

Product certification system:

The ICC-ES product certification system includes testing samples taken from the market or supplier's stock, or a combination of both, to verify compliance with applicable codes and standards. The system also involves factory inspections, and assessment and surveillance of the supplier's quality system.

Product: Cast Iron Soil Pipe and Fittings
 Listee: NEW AGE CASTING CO.
 12630 West Airport Blvd, Suite 100
 Sugar Land, Texas 77478
www.newagecasting.com

Compliance with the following codes:

2018, 2015, 2012 and 2009 *International Plumbing Code® (IPC)*
 2018, 2015, 2012 and 2009 *International Residential Code® (IRC)*
 2018, 2015, 2012 and 2009 *Uniform Plumbing Code® (UPC)**
 *Uniform Plumbing Code is a copyrighted publication of the International Association of the Plumbing and Mechanical Officials

Compliance with the following standards:

ASTM A888-2018a(excluding Annex A1), Standard Specification for Hubless Cast Iron Soil Pipe and Fittings for Sanitary and Storm Drain, Waste, and Vent Piping Applications
 CISPI 301-2012(excluding Annex A1), Standard Specification for Hubless Cast Iron Soil Pipe and Fittings For Sanitary and Storm Drain, Waste, and Vent Piping Applications

Identification:

Each length of pipe and each fitting shall be plainly marked with the country of origin, the manufacturer's name or the manufacturer's registered trademark by which the manufacturer can be readily identified after installation and any appropriate collective mark (optional). The marking shall be adequate identification of the manufacturer of the pipe and fittings of it readily identifies the manufacturer to the end user of the product. Markings shall be cast on fittings.

Pipe markings: The pipe shall be marked continuously on the barrel with a minimum of 0.75 inch (19mm) lettering starting within 3 inches of each end of the pipe. Each pipe shall be marked with the date of manufacture. The marking shall be stenciled on the pipe or otherwise applied so as to be clear and legible.

Listings are not to be construed as representing aesthetics or any other attributes not specifically addressed, nor are they to be construed as an endorsement of the subject of the listing or a recommendation for its use. There is no warranty by ICC Evaluation Service, LLC, express or implied, as to any finding or other matter in this listing, or as to any product covered by the listing.





SUBMITTAL: HUBLESS CAST IRON SOIL PIPE & FITTINGS

Welcome to the NewAge

12630 West Airport Blvd., Suite 100 • Sugar Land, Texas 77478 • Phone: 281.565.0928 • Fax: 281.565.0929 • Toll Free: 1-866.791.7055 • E-Mail: info@newagecasting.com

Date of Manufacture
Country of Origin
Foundry Trademark

NEWAGE PIPE 4" X 10' CISPI 301 ASTM A888 XXX XXX XXX

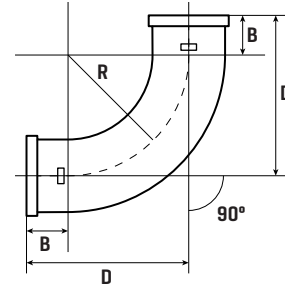
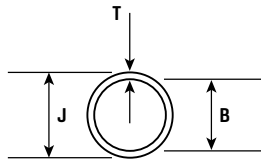

1/4 BEND

PART#	SIZE	B	D	R
0220188	1-1/2	1-1/2	4-1/4	2-3/4
0220190	2	1-1/2	4-1/2	3
0220192	3	1-1/2	5	3-1/2
0220194	4	1-1/2	5-1/2	4
0220196	5	2	6-1/2	4-1/2
0220198	6	2	7	5
0220200	8	2-1/2	8-1/2	6

NO-HUB - 10 FOOT PIPE

PART#	SIZE	B	J	NOM T	MIN
0220156	1-1/2	1.50	1.90	0.16	0.13
0220158	2	1.96	2.35	0.16	0.13
0220160	3	2.96	3.35	0.16	0.13
0220162	4	3.94	4.38	0.19	0.15
0220164	5	4.94	5.30	0.19	0.15
0220168	6	5.94	6.30	0.19	0.15
0220170	8	7.94	8.38	0.23	0.17
0220171	10	10.00	10.56	0.28	0.22
0220172	12	11.94	12.50	0.28	0.22
0220173	15	15.11	15.83	0.36	0.30

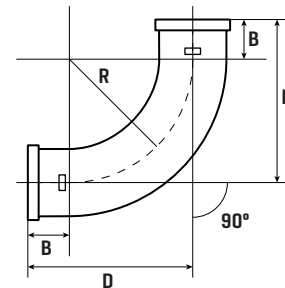

LONG SWEEP (1/4 BEND)

PART#	SIZE	B	D	R
220492	1-1/2	1-1/2	9-1/4	7-3/4
220494	2	1-1/2	9-1/2	8
220496	3	1-1/2	10	8-1/2
220498	4	1-1/2	10-1/2	9
220500	5	2	11-1/2	9-1/2
220502	6	2	12	10
0220200	8	2-1/2	8-1/2	6

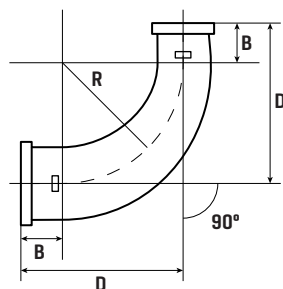

REDUCING 1/4 BEND

PART#	SIZE	B	D	R	W
220218	4 x 3	1-1/2	5 1/2	3-1/2	1-1/8

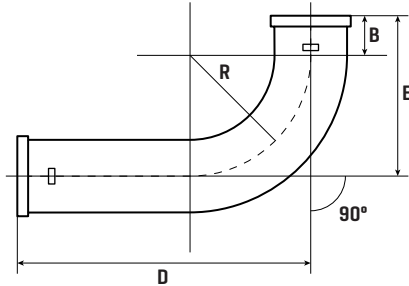

LONG 1/4 BEND

PART#	SIZE	B	D	E	R
220425	2 x 18	1-1/2	18	4-1/2	3

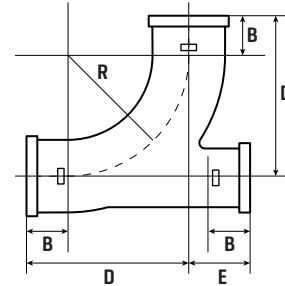

1/4 BEND WITH HEEL OPENING

PART#	SIZE	B	D	E	R
220280	3 x 2	1-1/2	5	2-7/8	3-1/2
220282	4 x 2	1-1/2	5-1/2	3-1/4	4

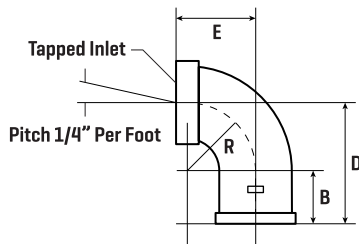

TAPPED 1/4 BEND

PART#	SIZE	B	D	E	R	TAP
220324	1-1/2 X 1-1/4	1-1/2	3	2	1-3/4	1-1/4
220326	1 1/2 X 1 1/2	1-1/2	3	2	1-3/4	1-1/2
220330	2 X 1-1/2	1-1/2	3-1/4	2-1/4	1-3/4	1-1/2
220332	2x2	1-1/2	3-1/4	2-1/4	1-3/4	2

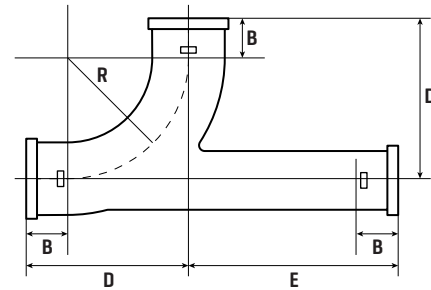

1/4 BEND WITH HEEL OPENING EXTENDED

PART#	SIZE	B	D	E	R
220275	3 x 2	1-1/2	5	10-1/2	3-1/2
220277	4 x 2	1-1/2	5-1/2	11 5/8	4

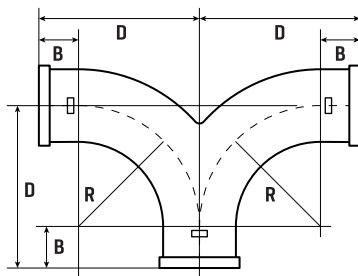

DOUBLE 1/4 BEND

PART#	SIZE	B	D	R
220402	2	1-1/2	4-1/2	3
220404	3	1-1/2	5	3-1/2
220406	4	1-1/2	5-1/2	4

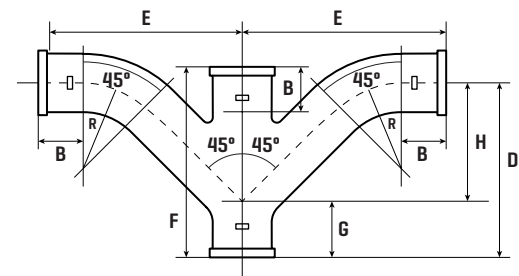

DOUBLE COMBINATION WYE AND 1/8 BEND

PART#	SIZE	B	D	E	F	G	H	R
221802	2	1-1/2	5-3/8	6-1/8	6-5/8	2	3-3/8	3
221804	3 x 2	1-1/2	5-1/2	7-1/4	6-5/8	1-1/2	4	3
221806	2	1-1/2	7-5/16	8	8	2-1/4	5-1/16	3-1/2
221808	4 x 2	1-1/2	5-1/2	7-1/4	6-5/8	1	4-1/2	3
221810	4 x 3	1-1/2	7-1/4	8-1/2	8	1-1/16	5-9/16	3-1/2
221812	4	1-1/2	9-1/4	10	9-1/2	2-7/16	6-13/16	4

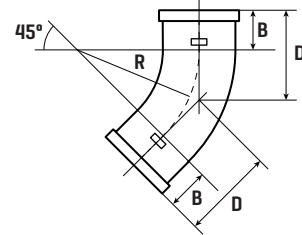
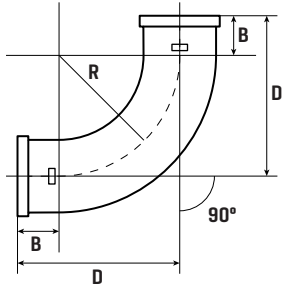

SHORT SWEEP 1/4 BEND

PART#	SIZE	B	D	R
220462	2	1-1/2	6-1/2	5
220464	3	1-1/2	7	5-1/2
220468	4	1-1/2	7-1/2	6
220470	5	2	8-1/2	6-1/2
220472	6	2	9	7
220474	8	2-1/2	10-1/2	8
220475	10	3	12	9
220476	12	3-1/2	13-1/2	10
220477	15	3-1/2	14-1/2	11-1/2

1/8 BEND

PART#	SIZE	B	D	R
220604	1-1/2	1-1/2	2 5/8	2 3/4
220606	2	1-1/2	2 3/4	3
220608	3	1-1/2	3	3-1/2
220610	4	1-1/2	3-1/8	4
220612	5	2	3-7/8	4-1/2
220614	6	2	4-1/16	5
220616	8	2-1/2	5	6
220617	10	3	5-15/16	7
220618	12	3 1/4	6-9/16	8
220619	15	3 1/4	7-3/16	9-1/2

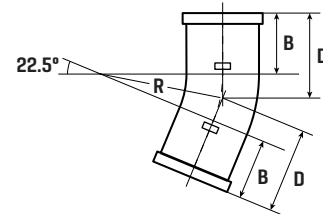
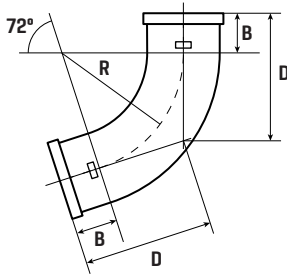

1/5 BEND

PART#	SIZE	B	D	R
220536	2	1-1/2	3-11/16	3
220538	3	1-1/2	4-1/16	3-1/2
220540	4	1-1/2	4-7/16	4

1/16 BEND

PART#	SIZE	B	D	R
220676	1-1/2	1-1/2	2-1/8	2-3/4
220678	2	1-1/2	2-1/8	3
220680	3	1-1/2	2-1/4	3-1/2
220682	4	1-1/2	2 5/16	4
220684	5	2	2-7/8	4-1/2
220686	6	2	3	5
220688	8	2-1/2	3-3/4	6

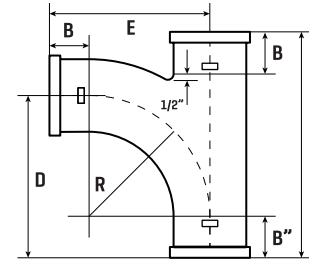
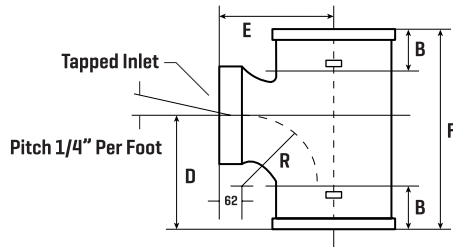

SANITARY TAP TEE

PART#	SIZE	B	D	E	F	R	TAP
221208	1-1/2 x 1-1/4	1-1/2	3-1/4	2-9/16	5-11/16	1-3/4	1-1/4
221210	1-1/2 x 1-1/2	1-1/2	3-1/4	2-9/16	5-11/16	1-3/4	1-1/2
221212	2 X 1-1/4	1-1/2	3-1/4	2-13/16	5-11/16	1-3/4	1-1/4
221214	2 X 1-1/2	1-1/2	3-1/4	2-13/16	5-11/16	1-3/4	1-1/2
221216	2 x 2	1-1/2	3-3/4	3-1/16	6-3/8	2-1/4	2
221220	3 x 1-1/2	1-1/2	3-1/4	3-5/16	5-11/16	1-3/4	1-1/2
221222	3 x 2	1-1/2	3-3/4	3-9/16	6-3/8	2-1/4	2
221223	3 x 3	1-1/2	4-7/8	4-3/16	8	3-1/2	3
221226	4 X 1-1/2	1-1/2	3-1/4	3-13/16	5-11/16	1-3/4	1-1/2
221228	4 x 2	1-1/2	3-3/4	4-1/16	6-3/8	2-1/4	2

SANITARY TEE

PART#	SIZE	B	B"	D	E	F	R
220806	1-1/2	1-1/2	1-1/2	4-1/4	4-1/4	6-1/2	2-3/4
220808	2 x 1-1/2	1-1/2	1-1/2	4-1/4	4-1/2	6-5/8	2-3/4
220810	2	1-1/2	1-1/2	4-1/2	4-1/2	6-7/8	3
220812	3 x 1-1/2	1-1/2	1-1/2	4-1/4	5	6-1/2	2-3/4
220814	3 x 2	1-1/2	1-1/2	4-1/2	5	6-7/8	3
220816	3	1-1/2	1-1/2	5	5	8	3-1/2
220818	4 x 2	1-1/2	1-1/2	4-1/2	5-1/2	6-7/8	3
220820	4 x 3	1-1/2	1-1/2	5	5-1/2	8	3-1/2
220822	4	1-1/2	1-1/2	5-1/2	5-1/2	9-1/8	4
220824	5 x 2	2	1-1/2	5	6-1/2	8-1/2	3
220826	5 x 3	2	1-1/2	5-1/2	6	9-5/16	3-1/2
220828	5 x 4	2	1-1/2	6	6	10-13/32	4
220830	5	2	2	6-1/2	6-1/2	11-7/16	4-1/2
220832	6 x 2	2	1-1/2	5	6-1/2	8-3/16	3
220834	6 x 4	2	1-1/2	6	6-1/2	10-11/16	4
220835	6 x 5	2	2	6-1/2	7	11-1/2	4-1/2
220836	6	2	2	7	7	12-1/2	5
220838	6 x 3	2	1-1/2	5-1/2	6-1/2	9-3/16	3-1/2
220848	8 x 3	2-1/2	1-1/2	6	7-1/2	10-3/8	3-1/2
220846	8 x 4	2-1/2	1-1/2	6-1/2	7-1/2	11-1/2	4
220844	8 x 5	2-1/2	2	7	8	12-1/2	4-1/2
220842	8 x 6	2-1/2	2	7-1/2	8	13-1/2	5
220840	8	2-1/2	2-1/2	8-1/2	8-1/2	15-1/2	6

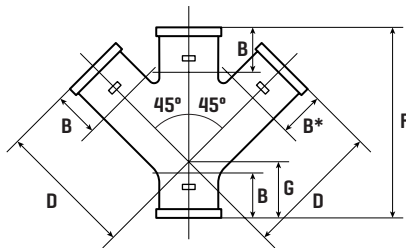

DOUBLE WYE

PART#	SIZE	B	B*	D	F	G
221538	2	1-1/2	1-1/2	4-5/8	6-5/8	2
221540	3 x 2	1-1/2	1-1/2	5-5/16	6-5/8	1-11/2
221542	3	1-1/2	1-11/2	5-3/4	8	2-1/4
221544	4 x 2	1-1/2	1-1/2	6	6-5/8	1
221546	4 x 3	1-1/2	1-11/2	6-1/2	8	1-11/16
221548	4	1-1/2	1-1/2	7-1/16	9-1/2	2-7/16
221552	6 x 4	2	1-1/2	9-1/4	11-3/16	1-15/16
221554	6	2	2	10-3/4	14-1/16	3-5/16
221557	8 x 6	2-1/2	2-3/4	11-13/16	14-13/16	2-5/16
221558	8	2-1/2	3-1/4	13-3/8	17-1/8	3-3/4

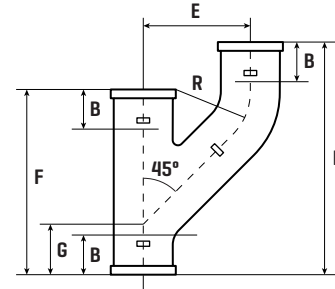
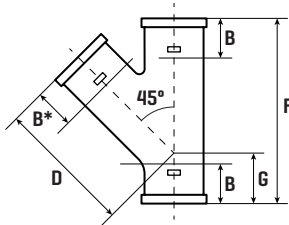

WYE

PART#	SIZE	B	B*	D	F	G
221312	1-1/2	1-1/2	1-1/2	4	6	2
221314	2	1-1/2	1-1/2	4-5/8	6-5/8	2
221316	3 x 2	1-1/2	1-1/2	5-5/16	6-5/8	1-1/2
221318	3	1-1/2	1-1/2	5-3/4	8	2-1/4
221320	4 x 2	1-1/2	1-1/2	6	6-5/8	1
221322	4 x 3	1-1/2	1-1/2	6-1/2	8	1-11/16
221324	4	1-1/2	1-1/2	7-1/16	9-1/2	2-7/16
221326	5 x 2	2	1-1/2	7-1/2	8-1/16	15/16
221328	5 x 3	2	1-1/2	8	9-11/16	1-11/16
221330	5 x 4	2	1-1/2	8-1/2	11-3/16	2-7/16
221332	5	2	2	9-1/2	12-5/8	3-1/8
221334	6 x 2	2	1-1/2	8-1/4	8-5/16	1/2
221336	6 x 3	2	1-1/2	8-3/4	9-3/4	1-1/4
221338	6 x 4	2	1-1/2	9-1/4	11-3/16	1-15/16
221340	6 x 5	2	2	10-1/4	12-1/2	2-9/16
221342	6	2	2	10-3/4	14-1/16	3-5/16
221344	8 x 2	2-1/2	2-1/4	9-3/8	8-1/2	9/16
221346	8 x 3	2-1/2	2-1/4	9-13/16	9-15/16	1/8
221348	8 x 4	2-1/2	2-1/4	10-3/8	11-7/16	15/16
221350	8 x 5	2-1/2	2-3/4	11-3/8	12-13/16	1-5/8
221352	8 x 6	2-1/2	2-3/4	11-13/16	14-3/16	2-5/16
221354	8	2-1/2	3-1/4	13-3/8	17-1/8	3-3/4
221357	10 x 4	3	2-1/2	11-11/16	12-5/8	3/4
221359	10 x 6	3	2	13-1/8	15-7/16	2-3/16
221360	10 x 8	3	2-1/2	14-11/16	18-3/8	3-5/8
221361	10	3	3-1/4	16-1/2	21-1/2	5-1/16
221362	12	3-1/4	3-1/4	19-3/4	25-1/2	5-3/4
221363	15	3-1/4	3-1/4	23-1/4	30	6-3/4

UPRIGHT WYE

PART#	SIZE	B	E	F	G	H	R
221646	2	1-1/2	5-1/2	7	2	8-1/4	3
221648	3 x 2	1-1/2	5-1/2	7	1-1/2	8-3/16	3
221650	3	1-1/2	5-1/2	8-3/8	2-3/16	8-7/16	3-1/2
221652	4 x 2	1-1/2	5-1/2	7	1	8-1/4	3
221654	4 x 3	1-1/2	5-1/2	8-3/8	1-11/16	8-7/16	3-1/2
221656	4	1-1/2	6	9-3/4	2-7/16	9-1/8	4

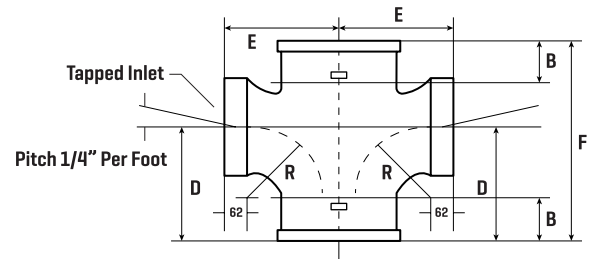

SANITARY TAP CROSS

PART#	SIZE	B	D	E	F	R	TAP
222012	1-1/2 x 1-1/2	1-1/2	3-1/4	2-9/16	5-11/16	1-3/4	1-1/2
222014	2 x 1-1/4	1-1/2	3-1/4	2-13/16	5-11/16	1-3/4	1-1/4
222016	2 x 1-1/2	1-1/2	3-1/4	2-13/16	5-11/16	1-3/4	1-1/2
222018	2 x 2	1-1/2	3 3/4	3-1/16	6-3/8	2-1/4	2
222022	3 x 1-1/2	1-1/2	3-1/4	3-5/16	5-11/16	1-3/4	1-1/2
222024	3 x 2	1-1/2	3 3/4	3-9/16	6-3/8	2-1/4	2
222028	4 x 1-1/2	1-1/2	3-1/4	3-13/16	5-11/16	1-3/4	1-1/2

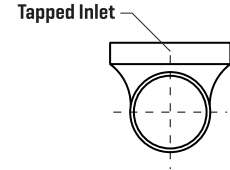
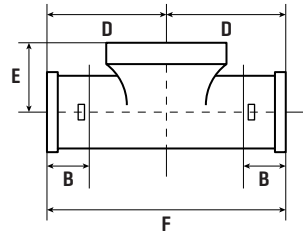
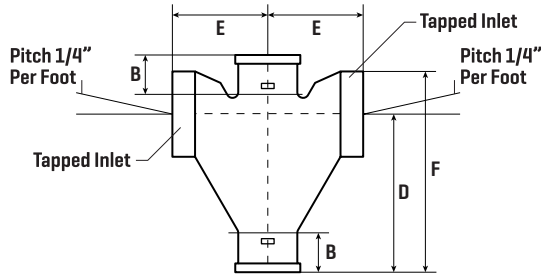
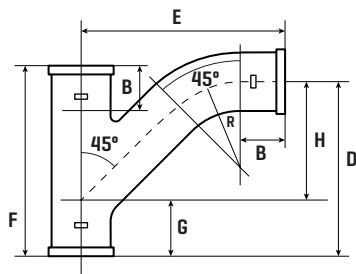

FIGURE ONE (TAP CROSS)

TEST TEE

PART#	SIZE	B	C	D	E	F	TAP
228002	2 x 1-1/2	1-1/2	2-1/8	4-7/8	3-3/16	7	1-1/2

PART#	SIZE	B	D	E	F	TAP
222046	2	1-1/2	3-3/16	2	6-3/8	2
222048	3	1-1/2	3-7/8	2-11/16	7-3/4	3
222050	4	1-1/2	4-7/16	3	8-7/8	4
222052	5	2	5-3/4	4-1/2	11-1/2	5
222054	6	2	6-1/4	5	12-1/2	6
222056	8	8	7-5/8	6	15-1/4	8
222058	10	4	10	6-1/2	20	10



COMBINATION WYE AND 1/8 BEND

PART#	SIZE	B	B*	D	E	F	G	H	R
221694	1-1/2	1-1/2	1-1/2	4-3/4	5-3/8	6	2	2-3/4	2-3/4
221696	2 x 1-1/2	1-1/2	1-1/2	57/8	6-1/8	6	2	3	3
221698	2	1-1/2	1-1/2	5-3/8	6-1/8	6-5/8	2	3-3/8	3
221700	3 x 2	1-1/2	1-1/2	5-1/2	6-3/4	6-5/8	1-1/2	4	3
221702	3	1-1/2	1-1/2	7-5/16	8	8	2-1/4	5-1/16	3-1/2
221704	4 x 2	1-1/2	1-1/2	5-1/2	7 1/4	6 5/8	1	4 1/2	3
221706	4 x 3	1-1/2	1-1/2	7-1/4	8-1/2	8	1-11/16	5-9/16	3-1/2
221708	4	1-1/2	1-1/2	9-1/4	10	9-1/2	2-7/16	6-13/16	4
221710	5 x 2	2	1-1/2	5-15/16	7-3/4	8-1/16	15/16	5	3
221712	5 x 3	2	1-1/2	7-3/4	9	9-11/16	1-11/16	6-1/16	3-1/2
221714	5 x 4	2	1-1/2	9-3/4	10-1/2	11-3/16	2-7/16	7-5/16	4
221716	5	2	2	11-3/4	12-1/2	12-5/8	3-1/8	8-5/8	4-1/2
221718	6 x 2	2	1-1/2	6	8-1/4	8-5/16	1/2	5-1/2	3
221720	6 x 3	2	1-1/2	7-13/16	9-1/2	9-3/4	1-1/4	6-9/16	3-1/2
221722	6 x 4	2	1-1/2	9-3/4	11	11-3/16	11-5/16	7-13/16	4
221724	6 x 5	2	2	14-11/16	13	12-1/2	2-9/16	9-1/8	4-1/2
221726	6	2	2	13-5/8	14-3/8	14-1/16	3-5/16	10-5/16	5
221728	8 x 4	2-1/2	1-1/2	9-7/16	11-5/16	11-3/16	7/8	8-9/16	4
221730	8 x 5	2-1/2	2	10-15/16	12-13/16	11-3/16	7/8	8-9/16	4
221732	6 x 6	2-1/2	2	12	13-3/8	13-15/16	2-1/4	9-3/4	5
221734	8	2-1/2	1-1/2	14-3/4	15-9/16	16-15/16	3-3/4	11	6

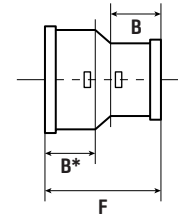
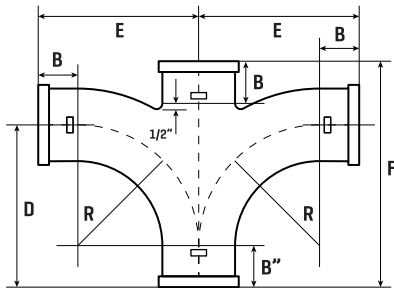

SANITARY CROSS

PART#	SIZE	B	D	E	F	R
1850	1-1/2	1-1/2	4-1/4	4-1/4	6-1/2	2-3/4
1852	2	1-1/2	4-1/2	4-1/2	6-7/8	3
1854	3 x 2	1-1/2	4-1/2	5	6-7/8	3
1856	3	1-1/2	5	5	8	3-1/2
1858	4 x 2	1-1/2	4-1/2	5-1/2	6-7/8	3
1860	4 x 3	1-1/2	5	5-1/2	8	3-1/2
1862	4	1-1/2	5-1/2	5-1/2	9-1/8	4
1864	6 x 4	2	6	6-1/2	10-1/16	4
1867	6	2	7	10-1/16	7	5
1874	8 x 4	2-1/2	7-1/2	11-1/2	6-1/2	4

SHORT INCREASER REDUCER

PART#	SIZE	B	B*	F
222138	2 x 1-1/2	1-1/2	1-1/2	3-5/8
222140	3 x 2	1-1/2	1-1/2	3-5/8
222142	4 x 2	1-1/2	1-1/2	3-5/8
222144	4 x 3	1-1/2	1-1/2	3-5/8
222146	5 x 2	1-1/2	2	4
222148	5 x 3	1-1/2	2	4
222150	5 x 4	1-1/2	2	4
222152	6 x 2	1-1/2	2	4
222154	6 x 3	1-1/2	2	4
222156	6 x 4	1-1/2	2	4
222158	6 x 5	2	2	4-1/2
222160	8 x 2	1-1/2	2	4-1/2
222162	8 x 3	1-1/2	2	4-1/2
222164	8 x 4	1-1/2	2	4-1/2
222166	8 x 5	2	2	5
222168	8 x 6	2	2	5
222172	10 x 4	1-1/2	3	5-1/2
222174	10 x 6	2	3	6
222175	10 x 8	2	3	6
222176	12 x 4	1-1/2	3-1/4	6-1/2
222177	12 x 6	2	3-1/4	6-1/2
222178	12 x 8	2-1/2	3-1/4	7
222179	12 x 10	3	3-1/4	7-1/2
222180	15 x 4	1-1/2	3-1/4	7
222181	15 x 6	2	3-1/4	7
222182	15 x 8	2-1/2	3-1/4	7
222183	15 x 10	3	3-1/4	7-1/2
222184	15 x 12	3-1/4	3-1/4	7-3/4

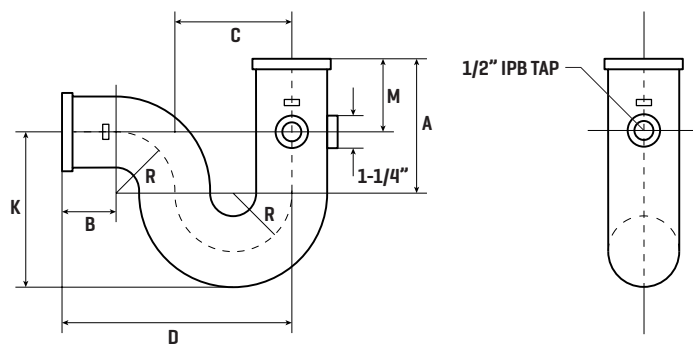

P-TRAP W/1/2" PRIMER CAP

PART#	SIZE	A	B	C	D	J	K	R	M
228530	2	2	1-1/2	4	7-1/2	4	0	2	2
228532	3	3-1/4	1-1/2	5	9	5-1/2	1/2	2-1/2	2
228534	4	4	1-1/2	6	10-1/2	6-1/2	1/2	3	2

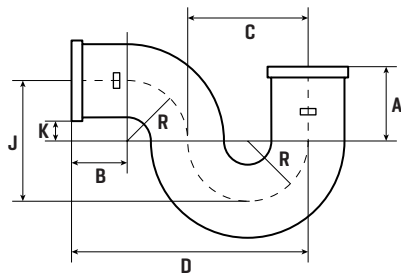

P-TRAP

PART#	SIZE	A	B	C	D	J	K	R
222508	2	2	1-1/2	4	7-1/2	4	0	2
222510	3	3-1/4	1-1/2	5	9	5-1/2	1/2	2-1/2
222512	4	4	1-1/2	6	10-1/2	6-1/2	1/2	3

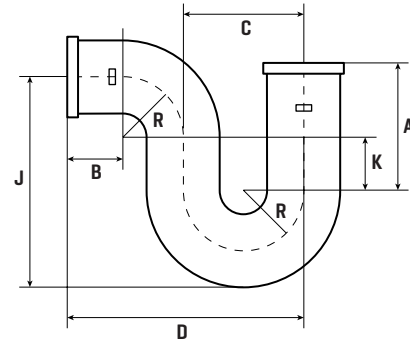

DEEP SEAL TRAP

PART#	SIZE	A	B	C	D	J	K	R
222564	2	5	1-1/2	4	7-1/2	7	3	2
222566	3	4-1/2	1-1/2	5	9	7	2	2-1/2
222567	4	5	1-1/2	6	10-1/2	8	2	3

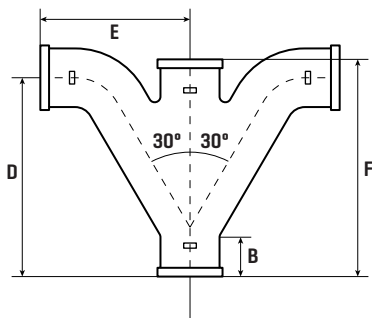
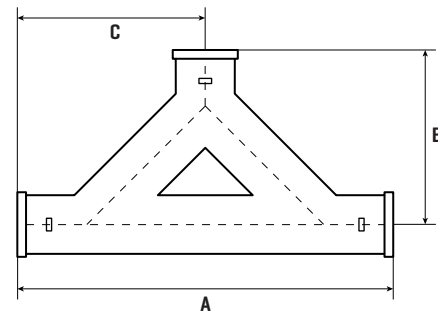

FIGURE FIVE (COMB)

PART#	SIZE	B	D	E	F
228057	2	1-1/2	6-1/2	5	8
228054	3 x 2 x 3 x 3	1-1/2	8-7/8	6-9/16	9-1/4
228056	3	1-1/2	8-7/8	6-9/16	10-1/8
228058	4 x 2 x 4 x 4	1-1/2	10-1/4	7-3/4	11-1/2
228062	4	1-1/2	10-1/4	7-3/4	12
222567	4	5	1-1/2	6	10-1/2



TWO WAY BAFFLE CLEANOUT

PART#	SIZE	A	B	C
228442	3 x 3 x 4	15	9	7-1/2
228444	4 x 3 x 4	19-1/2	9-1/2	9-1/8
228446	4 x 4 x 4	18-3/4	9-1/2	9-1/8

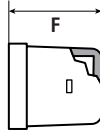

BLIND PLUG

PART#	SIZE	F
222480	1-1/2	1-3/4
222482	2	1-3/4
222484	3	1-3/4
222486	4	1-3/4
222490	6	1-3/4
222492	8	2-1/4
222494	10	3
222495	12	3-1/2
222496	15	3-11/2

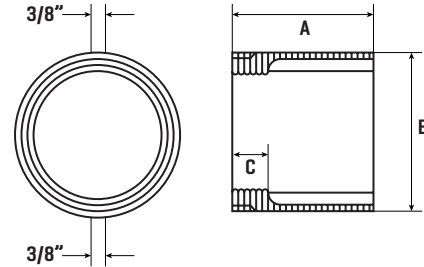

CLEANOUT FERRULE (I.B.C.O)

PART#	SIZE	A	B	TAP
228562	2	2-3/16	2-3/8	1-1/2
228564	3	2-3/16	3-3/8	2-1/2
228566	4	2-3/16	4-7/16	3-1/2
228570	6	4-1/2	6-5/16	5

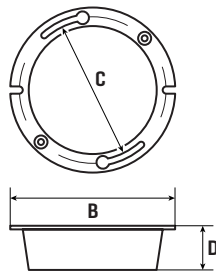

CLOSET FLANGE

PART#	SIZE	B	D	C
229426	4 x 2	7-1/4	2	6-1/4
222968	4 x 3	7-1/4	3	6-1/4
228413	4 x 4	7-1/4	4	6-1/4

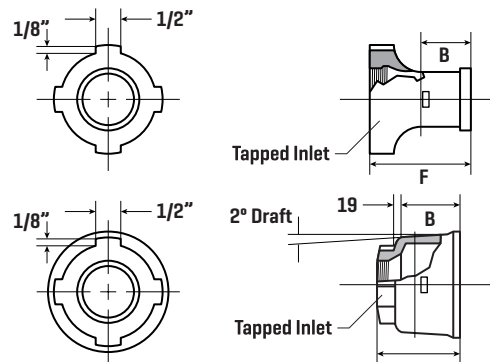

TAP ADAPTER/FERRULE

PART#	SIZE	B	F	TAP
222242	2 x 1-1/2	1-1/2	2-3/16	1-1/2
222244	2	1-1/2	2-5/8	2



GENERAL TERMS AND CONDITIONS

GENERAL

These terms and conditions shall control with respect to any purchase order or sale of Sellers products. No waiver, alteration or modification of these terms and conditions whether on Buyers purchase order or otherwise shall be valid unless the waiver, alteration, or modification is specifically accepted in writing and signed by an authorized representative of Seller.

DELIVERY

Seller will make any effort to complete delivery of products as indicated on Sellers acceptance of an order, but Seller assumes no responsibility or liability, and will accept no back charge, for loss or damage due to delay or inability to deliver caused by acts of God, war, labor difficulties, accident, delays of carriers, by contractors or suppliers, inability to obtain materials, shortages of fuel or energy, or any other causes of any kind whatsoever beyond the control of Seller. Seller may terminate any contract of sale of its products without liability of any nature, by written notice of Buyer, in the event that the delay in delivery or performance resulting from any of the aforesaid causes shall continue for a period of sixty (60) days. Under no circumstances shall Seller be liable for any special or consequential damages or for loss, damage, or expense [whether or not based on negligence] directly or indirectly arising from delays or failure to give notice of delay.

WARRANTY

Seller warrants for five years from the date of shipment Sellers manufactured products to the extent that Seller will replace those having defects in material or workmanship when used for the purpose and in the manner which Seller recommends. If Sellers examination shall disclose to its satisfaction that the product is defective, and an adjustment is required, the amount of such adjustment shall the not exceed the net sales price of the defective products only and no allowance will be made for labor or expense of repairing or replacing defective product or workmanship or damage resulting from the same. No adjustment shall be implemented unless product in question is returned to seller in its originally installed condition, still connected to other components of the joint. Buyer must contact Seller as quickly as possible so Seller can assess product in its installed condition. No claims will be honored unless claim is made within forty five (45) days of the defect being found. Where engineering design or fabrication work is supplied, Buyers acceptance of Sellers design or of delivery of work shall relieve Seller of all further obligation, other than expressed in Sellers product warranty. THIS IS SELLERS SOLE WARRANTY. SELLERS MAKES NO OTHER WARRANTY OF ANY KIND, EXPRESSED OR IMPLIED AND ALL IMPLIED WARRANTIES OF MERCHANTABILITY AND FITNESS FOR A PARTICULAR PURPOSE WHICH EXCEED SELLERS AFORESTATED OBLIGATION ARE HEREBY DISCLAIMED BY SLLER AND EXCLUDED FROM THIS WARRANTY. Seller neither assumes, nor authorizes any person to assume for it, any other obligation in connection with the sale of its engineering designs or product. This warranty shall not apply to any products or parts of products which [a] have been repaired or altered outside of Sellers factory, in any manner; [b] have been subjected to misuse, negligence or accidents; [c] have been used in a manner contrary to Sellers instructions or recommendations. Seller shall not be responsible for design errors due to inaccurate or incomplete information supplied by Buyer or its representatives. This warranty is non-transferable.

LIABILITY

Seller will not be liable for any loss, damage, cost of repairs, incidental or consequential damages of any kind, whether based upon warranty [except for the obligation accepted by Seller under warranty above], contract or negligence, arising in connection with the design, manufacture, sale, use or repair of the products or of the engineering designs supplied to Buyer.

RETURNS

Seller cannot accept return of any products unless its written permission has been first obtained, in which case same will be credited subject to the following: [a] All material returned must, on its arrival at Sellers plant, be found to be in first-class condition; if not, cost of putting in saleable condition will be deducted from credit memoranda; [b] A handling charge deduction of twenty five percent (25%) will be made from all credit memoranda issued for material returned; [c] transportation charges, if not prepaid will be deducted from credit memoranda.

SHIPMENTS

All products sent out will be carefully examined, counted, and packed. The cost of any special packing or special handling caused by Buyers requirements or request shall be added to the amount of the order. No claim for shortages will be allowed unless made in writing within ten (10) days of receipt of a shipment. Claims for products damaged or lost in transit should be made on the carrier, as Sellers responsibility ceases, and title passes, on delivery to the carrier.

PRODUCTS

Orders covering special or non-standard products are not subject to cancellation except on such terms as Seller may specify on application.

PRICES

Prices and designs are subject to change without notice. All prices are F.O.B. Point of Shipment, unless otherwise stated.

TAXES

The amount of any sales, excise or other taxes, if any, applicable to the products covered by this order, shall be added to the purchased price and shall not be paid by Buyer unless buyer provides Seller with an exemption certificate acceptable to the taxing authorities.

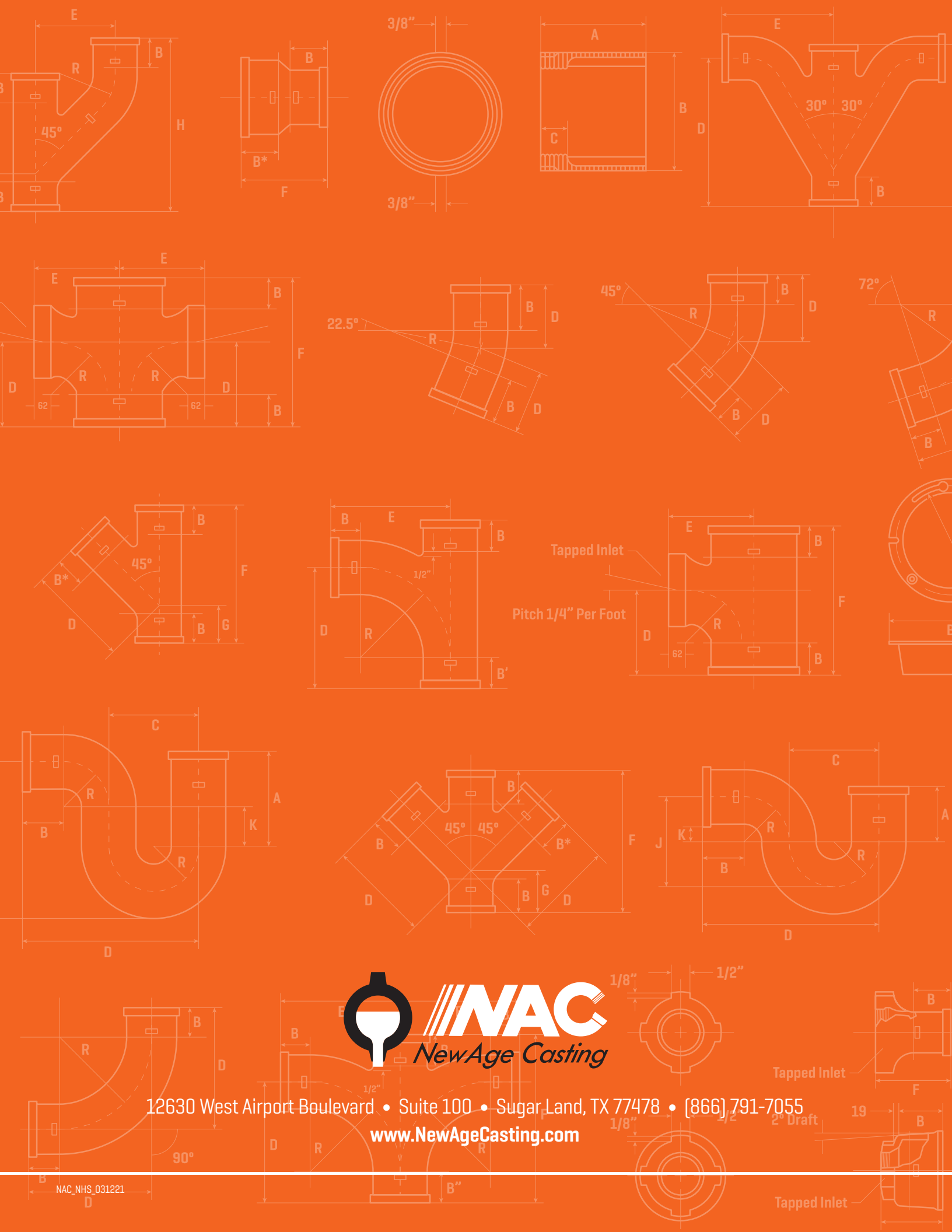

12630 West Airport Boulevard • Suite 100 • Sugar Land, TX 77478 • (866) 791-7055

www.NewAgeCasting.com

NAC_NHS_031221